



## **Table of contents**

























### **for machine: IR 17 ab 235**











<b>1 - Frame</b>	6
28 - Switch	11
29 - Switch	12
<b>2 - Protection device</b>	13
2 - Hood	15
4 - Protective guard	17
7 - Bracket	18
8 - Protective guard	19
<b>3 - Needle beam</b>	20
1 - Block	26
2 - Block	28
23 - Distributor unit	29
3 - Bushing	31
47 - Plate	32
50 - Shaft	33
<b>4 - Drive</b>	34
17 - Connecting Rod	39
<b>5 - Conveyor belt</b>	40
1 - Conveyor belt	43
19 - Filter	45
<b>6 - Pump</b>	46
1 - Pump	48
<b>7 - Switch box</b>	49
<b>8 - Hose laying</b>	55
<b>9 - Power supply</b>	59
<b>10 - Equipment</b>	61

IR 17 ab 235



## IR 17 ab 235







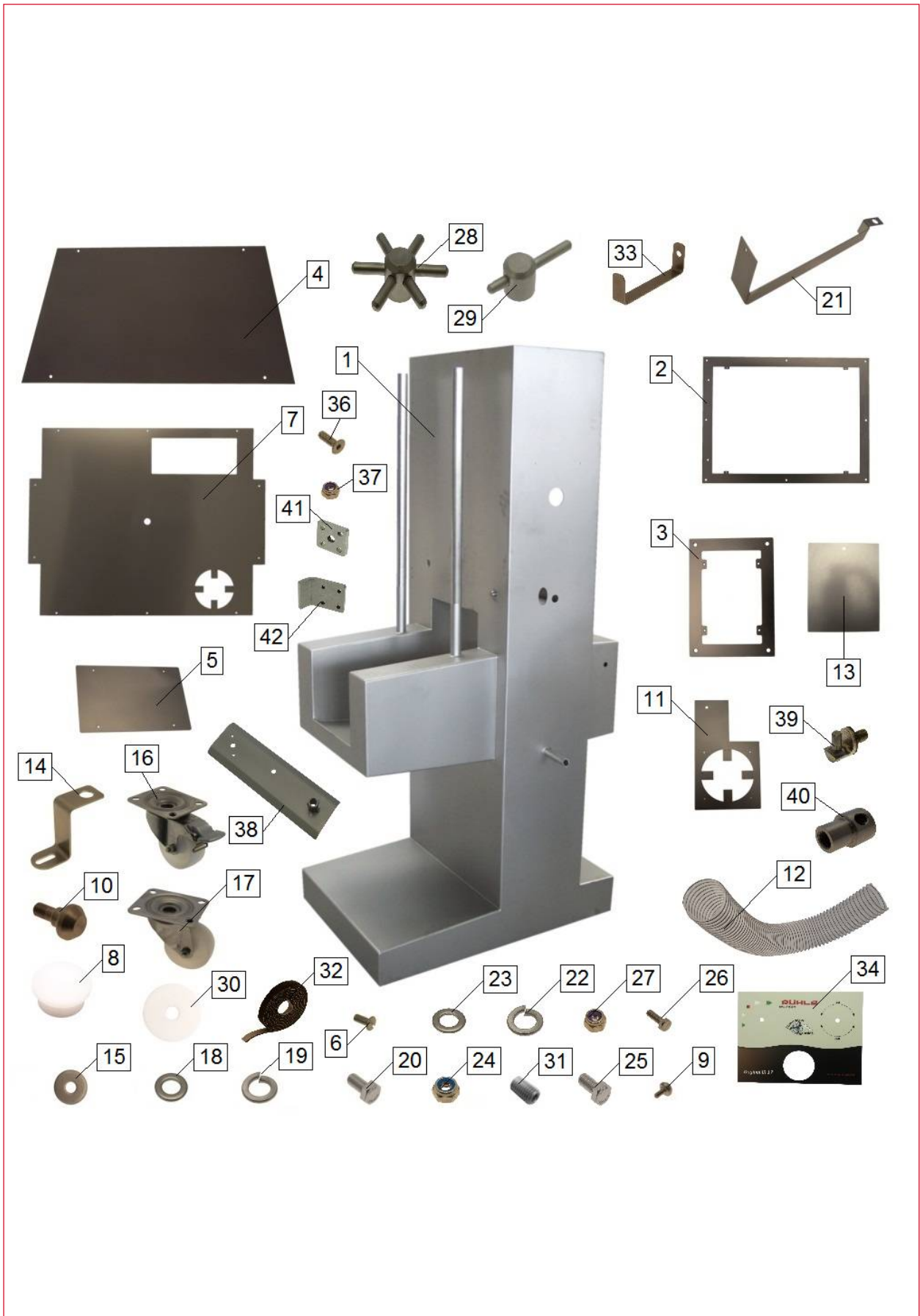







		<i>Position No.</i>	<i>Part No.</i>	<i>Designation</i>	<i>Quantity</i>	
		1	8IR1704	Frame IR 17	1 Stk	
		2	8IR1703	Protection device IR 17	1 Stk	
		3	114151	Needle beam IR 17	1 Stk	
		4	8IR1705	Drive IR 17	1 Stk	
		5	109225	Conveyor belt IR 17	1 Stk	
		6	114105	Pump IR 17	1 Stk	
		7	109720et	Switch box IR 17	1 Stk	
		8	109468	Hose laying IR 17	1 Stk	
		9	8IR1701	Power supply IR 17	1 Stk	
		10	8IR1702	Equipment IR 17	1 Stk	
		12	F249083	Threaded rod M 10 x 90	1 Stk	



















		<i>Position No.</i>	<i>Part No.</i>	<i>Designation</i>	<i>Quantity</i>	
		13	F20147	Hexagonal nut DIN934 m 10	2 Stk	
		14	F20417	Hexagonal bolt DIN933 m 6 x 16	4 Stk	
		15	114499	Bracket 82 x 26 x 40,5 x 2,5	1 Stk	
		16	114505	Cover 90 x 60 x 2,5	1 Stk	
		17	114506	Disc d 15,2 x d 47 x 1	2 Stk	

## 1 - Frame - 8IR1704













## 1 - Frame - 8IR1704

		<i>Position No.</i>	<i>Part No.</i>	<i>Designation</i>	<i>Quantity</i>	
		2	108896	Frame 660 x 500 x 2,5	1 Stk	
		3	108897	Frame 220 x 160 x 2,5	1 Stk	
		4	108902	Lid 599 x 439 x 1,5	1 Stk	
		5	108904	Lid 180 x 120 x 2,5	1 Stk	
		6	F25828	Countersunk bolt DIN963 M 4 x 10	8 Stk	
		7	109410	Plate / Sheet 720 x 570 x 25,5 x 0,5	1 Stk	
		8	109060	Plug d 30 x 27,5	2 Stk	
		9	109123	Pin d 17 x 20	1 Stk	
		10	109350	Pin d 15 x 23	2 Stk	
		11	109533	Plate / Sheet 250 x 150 x 26,5 x 1,5	1 Stk	
		12	110038	Hose Ø 120 x 1040	1 Stk	







		<i>Position No.</i>	<i>Part No.</i>	<i>Designation</i>	<i>Quantity</i>	
		13	109570	Plate / Sheet 185 x 149 x 1,5	1 Stk	
		14	F240681a	Bracket 85,5 x 63 x 30	1 Stk	
		15	F21035	Disc Ø 6,5 x Ø 20 x 2	14 Stk	
		16	106966	Guide roller LEX-PO-75G-FI	2 Stk	
		17	109242	Guide Roller LEX-PO-75G	2 Stk	
		18	F22888	Washer DIN125 A 8,4	16 Stk	
		19	F21260	Spring lock washer DIN127 B 8	16 Stk	
		20	F21281	Hexagonal bolt DIN933 M 8 x 16	16 Stk	
		21	109583	Bracket 366 x 104 x 92,7 x 2	1 Stk	
		22	F24031	Spring lock washer DIN127 B 6	2 Stk	
		23	F20258	Washer DIN125 A 6,4	13 Stk	
		24	F250798	Hexagonal nut DIN985 M 6	19 Stk	









		<i>Position No.</i>	<i>Part No.</i>	<i>Designation</i>	<i>Quantity</i>	
		25	F26993	Hexagonal bolt DIN933 M 5 x 10	10 Stk	
		26	108699	Hexagonal bolt DIN933 M 4 x 12	4 Stk	
		27	F250796	Hexagonal nut DIN985 M 4	4 Stk	
		28	114488	Switch IR 17	1 Stk	
		29	114489	Switch IR 17	1 Stk	
		30	114486	Disc d 7 x d 25 x 1	2 Stk	
		31	F20640	Threaded pin DIN916 M 5 x 8	2 Stk	
		32	109482	Seal 9 x 2 black	3600 mm	
		33	109833	Plate / sheet IR 17	1 Stk	
		35	114429	Sticker 248 x 192	1 Stk	
		36	F251911	Countersunk bolt DIN7991 M 4 x 12	16 Stk	
		37	F250796	Hexagonal nut DIN985 M 4	16 Stk	

		<i>Position No.</i>	<i>Part No.</i>	<i>Designation</i>	<i>Quantity</i>	
		38	114490	Bracket IR 17	1 Stk	
		39	114493	Bracket IR 17	1 Stk	
		40	109496	Connector d 25 x 34	1 Stk	
		41	114495	Plate 40 x 40 x 6	1 Stk	
		42	114704	Housing 66 x 40 x 6	1 Stk	

## 28 - Switch - 114488

		<i>Position No.</i>	<i>Part No.</i>	<i>Designation</i>	<i>Quantity</i>	
		1	114483	Housing d 25 x 28	1 Stk	
		2	111001	Pin Ø 8 x 32	5 Stk	
		3	111003	Pin Ø 8 x 35,5	1 Stk	

## 29 - Switch - 114489

		<i>Position No.</i>	<i>Part No.</i>	<i>Designation</i>	<i>Quantity</i>	
		1	114482	Housing d 25 x 28	1 Stk	
		2	114485	Pin d 8 x 42	1 Stk	
		3	114484	Pin d 8 x 28	1 Stk	

## 2 - Protection device - 8IR1703

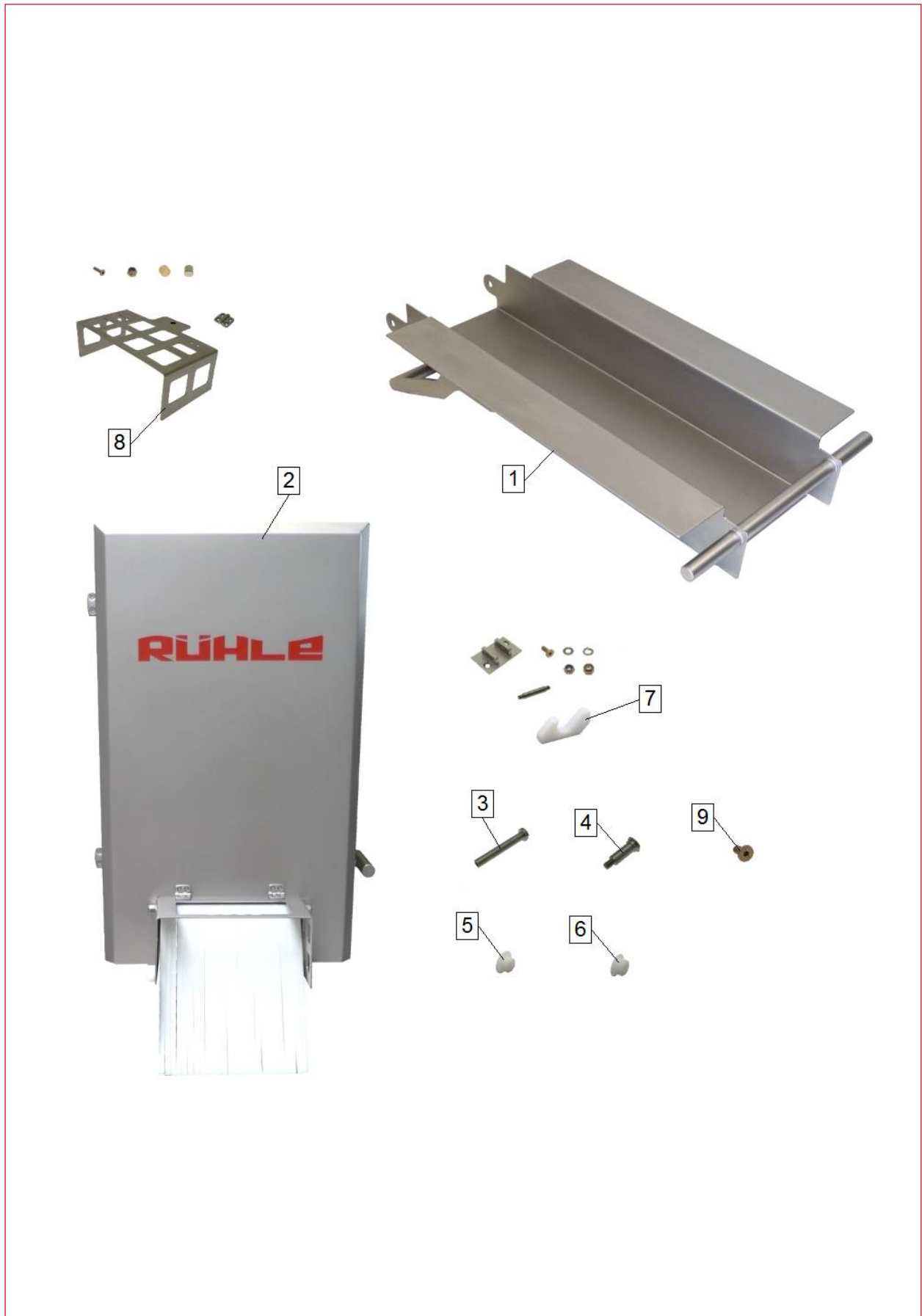







## 2 - Protection device - 8IR1703

		<i>Position No.</i>	<i>Part No.</i>	<i>Designation</i>	<i>Quantity</i>	
		1	114625	Table IR 17	1 Stk	
		2	114618	Hood IR 17	1 Stk	
		3	114629	Bolt d 20 x 87,8	2 Stk	
		4	114630	Bolt d 20 x 42,5	2 Stk	
		5	114631	Plug d 22 x 10	2 Stk	
		6	114632	Plug d 22 x 10	2 Stk	
		7	114621	Bracket IR 17	1 Stk	
		8	114628	Protective guard IR 17	1 Stk	
		9	F21688	Countersunk bolt DIN7991 M 5 x 10	2 Stk	

## 2 - Hood - 114618

		<i>Position No.</i>	<i>Part No.</i>	<i>Designation</i>	<i>Quantity</i>	
		1	114608	Hood IR 17	1 Stk	
		2	114205	Hinge 100-53-1	2 Stk	
		3	114206	Hinge 100-54-1	2 Stk	
		4	114605	Protective guard IR 17	1 Stk	
		6	107592	Slide bushing DIN1850 - J15 x 17 x 10	1 Stk	
		7	114615	Handle IR 17	1 Stk	
		8	113865	Disc d 16 x 2,5	1 Stk	
		9	F20048	Countersunk bolt DIN7991 M 6 x 16	1 Stk	
		10	114616	Plate / sheet 252 x 70 x 5	1 Stk	
		11	114617	Disc d 12 x d 25 x 9	1 Stk	
		12	F252390	Countersunk bolt DIN7991 M 4 x 14	8 Stk	

		<i>Position No.</i>	<i>Part No.</i>	<i>Designation</i>	<i>Quantity</i>	
		13	F250796	Hexagonal nut DIN985 m 4	8 Stk	
		14	F20453	Countersunk bolt DIN7991 m 6 x 20	8 Stk	
		15	F250798	Hexagonal nut DIN985 m 6	8 Stk	
		16	F28958	Ring Ø 15,2 x Ø 25 x 1,5	1 Stk	
		17	114718	Reinforcement 803,3 x 484 x 257,3 x 2,5	1 Stk	
		18	F26600	Disc Ø 8,5 x Ø 20 x 2	1 Stk	
		19	F254273	Hexagonal nut DIN985 m 8	1 Stk	
		20	114724	Sliding tape 120 x 0,65	20 mm	















## 4 - Protective guard - 114605

		<i>Position No.</i>	<i>Part No.</i>	<i>Designation</i>	<i>Quantity</i>	
		1	114604	Protective guard	1 Stk	
		2	109281	Shaft d 10 x 298	1 Stk	
		3	109668	Protection lug 317 x 22 x 10	2 Stk	
		4	109168	Protection lug 320 x 22 x 10	24 Stk	
		5	109666	Ring d 10,5 x d 15 x 8	2 Stk	
		6	F27693	Washer DIN125 A 10,5	2 Stk	
		7	F20811	Cap nut DIN917 M 10	2 Stk	
		8	109562	Solenoid housing 35 x 15 x 16	1 Stk	
		9	F20426	Solenoid Ø 10 x 10	1 Stk	
		10	109407	Countersunk head screw DIN 7972 3,9 x 9,5	2 Stk	

## 7 - Bracket - 114621

		<i>Position No.</i>	<i>Part No.</i>	<i>Designation</i>	<i>Quantity</i>	
		1	114620	Bracket IR 17	1 Stk	
		2	113670	Bracket 90 x 40 x 20	1 Stk	
		3	F20048	Countersunk bolt DIN7991 M 6 x 16	2 Stk	
		4	F20258	Washer DIN125 A 6,4	4 Stk	
		5	F24031	Spring lock washer DIN127 B 6	2 Stk	
		6	F250798	Hexagonal nut DIN985 M 6	2 Stk	
		7	113885	Bolt d 8 x 48,5	1 Stk	
		8	F20810	Cap nut DIN917 M 6	2 Stk	



## 8 - Protective guard - 114628

		<i>Position No.</i>	<i>Part No.</i>	<i>Designation</i>	<i>Quantity</i>	
		1	114627	Protective guard	1 Stk	
		2	114205	Hinge 100-53-1	2 Stk	
		3	105648	Bushing Ø 12 x 9	1 Stk	
		4	F20426	Solenoid Ø 10 x 10	1 Stk	
		5	F252390	Countersunk bolt DIN7991 M 4 x 14	8 Stk	
		6	F250796	Hexagonal nut DIN985 M 4	8 Stk	

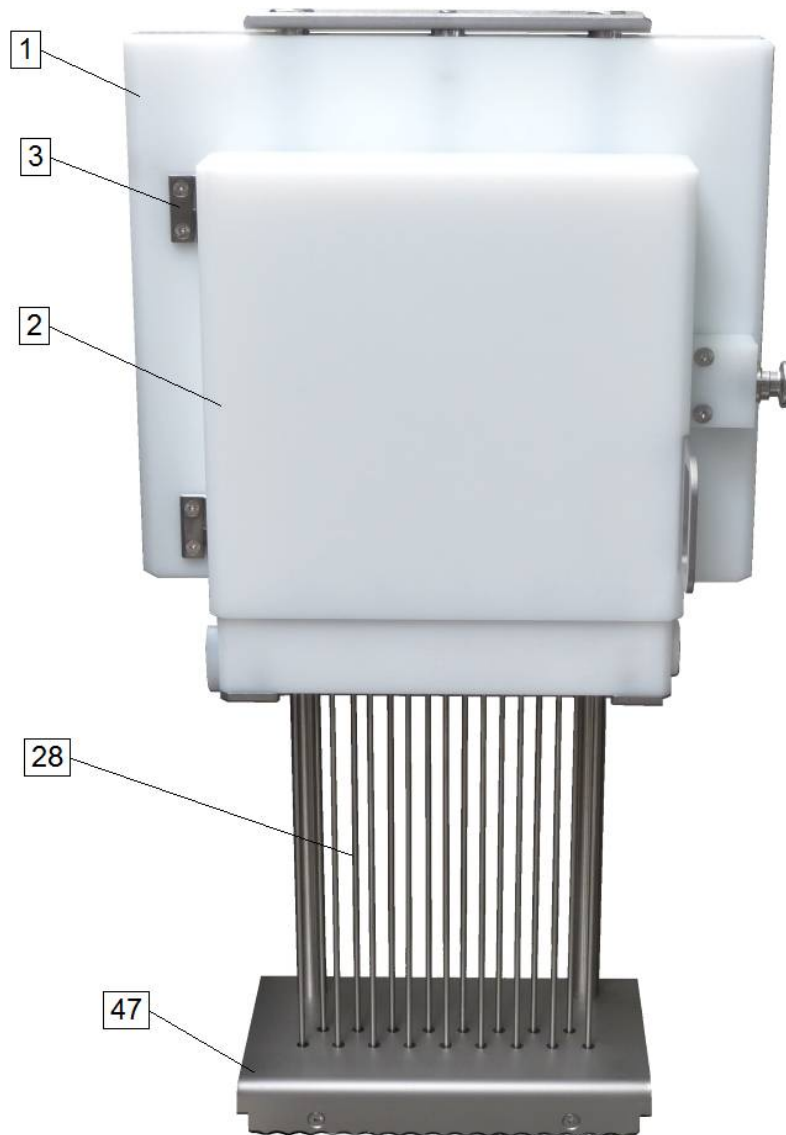
## 3 - Needle beam - 114151



## 3 - Needle beam - 114151







		<i>Position No.</i>	<i>Part No.</i>	<i>Designation</i>	<i>Quantity</i>	
		1	114148	Block IR 17 / IR 17 Turbo	1 Stk	
		2	114149	Block IR 17	1 Stk	
		4	111810	Hinge 218-9301	2 Stk	
		5	113703	Bolt d 12 x 71	1 Stk	
		6	106973	Lid M 22 x 1,5 x 8	1 Stk	
		7	F248042	Pressure spring d1.25 x De13.75 x 27	1 Stk	
		8	F20598	Countersunk bolt DIN7991 M 5 x 12	12 Stk	
		9	114435	Shaft d 20 x 278,5	1 Stk	
		10	F252764	Hexagonal nut DIN439 M 16 x 1,5	4 Stk	
		11	F21243	Cylinder head screw DIN84 M 6 x 12	1 Stk	
		12	114017	Ram IR 29	1 Stk	

		<i>Position No.</i>	<i>Part No.</i>	<i>Designation</i>	<i>Quantity</i>	
		13	113713	Bolt d 25 x 37,8	1 Stk	
		14	113690	Lever 67 x 25 x 20	1 Stk	
		15	113865	Disc d 16 x 2,5	1 Stk	
		16	F20048	Countersunk bolt DIN7991 M 6 x 16	1 Stk	
		17	113450	Slide bushing ZFM - 8 x 10 x 5,5	3 Stk	
		18	114082	Plate / sheet 59 x 12 x 2,5	1 Stk	
		19	113866	Plate / sheet 58 x 12 x 2,5	1 Stk	
		20	113711	Bolt d 10 x 24	2 Stk	
		21	F21028	Hexagonal nut DIN934 M 5	2 Stk	
		22	114141	Bracket 270 x 132 x 40 x 5	1 Stk	
		23	114150	Distributor unit IR 17 / IR 17 Turbo	1 Stk	
		24	113698	Disc d 8,3 x d 15 x 2,5	2 Stk	

		<i>Position No.</i>	<i>Part No.</i>	<i>Designation</i>	<i>Quantity</i>	
	25	113448	Slide bushing ZFM-12-14-20	1 Stk		
	26	113451	Slide bushing ZSM-0810-06	1 Stk		
	27	113712	Bolt d 10 x 18	1 Stk		
	28	110657	Curing needle Ø 4,0 x 331	17 Stk		
	30	114275	Bushing d 20,5 x d 30 x 13	2 Stk		
	32	113918	Bolt d 25 x 198,5	2 Stk		
	33	F29102	Threaded insert M 6 x M 10 x 14	8 Stk		
	34	F20453	Countersunk bolt DIN7991 M 6 x 20	12 Stk		
	35	F20264	Countersunk bolt DIN963 M 6 x 16	1 Stk		
	36	113926	Lid 111,6 x 100 x 2,5	1 Stk		
	37	114601	Mushroom-shaped button d 28 x 12	1 Stk		
	38	F20834	Countersunk bolt DIN7991 M 8 x 35	1 Stk		















		<i>Position No.</i>	<i>Part No.</i>	<i>Designation</i>	<i>Quantity</i>	
		39	114144	Connecting rod 353 x 35 x 12	1 Stk	
		40	114697	Slide bushing J3FM-1416-12	2 Stk	
		41	113876	Ring d 14,2 x d 25 x 1,8	2 Stk	
		42	113795	Cylindrical pin d 6 x 21,5	1 Stk	
		43	F23418	Disc Ø 8,5 x Ø 35 x 3	2 Stk	
		44	F21281	Hexagonal bolt DIN933 M 8 x 16	2 Stk	
		45	F21260	Spring lock washer DIN127 B 8	2 Stk	
		46	F22618	Countersunk bolt DIN7991 M 8 x 30	4 Stk	
		47	114492	Plate IR 17	1 Stk	
		48	114445	Plate / sheet 235 x 64 x 10,4 x 3	1 Stk	
		49	F21035	Disc Ø 6,5 x Ø 20 x 2	1 Stk	
		50	114448	Shaft IR 17 / IR 17 Turbo	2 Stk	



















		<i>Position No.</i>	<i>Part No.</i>	<i>Designation</i>	<i>Quantity</i>	
		51	113406	Disc d 10,5 x d 13,5 x 1	1 Stk	
		52	114161	Bushing d 25 x 33	1 Stk	
		53	114504	Spring d 1,4 x Da 12,7 x 44,45	2 Stk	

## 1 - Block - 114148

		<i>Position No.</i>	<i>Part No.</i>	<i>Designation</i>	<i>Quantity</i>	
		1	114137	Block 380 x 330 x 60	1 Stk	
		2	106839	Slide bushing JUM-01-30	4 Stk	
		3	113730	Bushing M 44 x 1,5 x d 32 x 44	2 Stk	
		4	106828	Bushing Ø 42 x Ø 20,5 x 20	2 Stk	
		5	113844	Flange d 70 x 45	1 Stk	
		6	110011	Countersunk bolt DIN 7991 M 6 x 30	4 Stk	
		7	F29102	Threaded insert M 6 x M 10 x 14	8 Stk	
		9	F22368	Pressure spring d3.0 x De38 x 350	2 Stk	
		10	F255839	Thread insert M 5 x M 8 x 10	8 Stk	
		11	113735	Housing 50 x 40 x 35	1 Stk	
		12	113848	Countersunk bolt DIN7991 M 6 x 45	2 Stk	





		<i>Position No.</i>	<i>Part No.</i>	<i>Designation</i>	<i>Quantity</i>	
		13	113433	Slide bushing JUM-01-20	1 Stk	
		14	F29103	Threaded insert M 8 x M12x1,5 x 15	1 Stk	
		15	F20130	Cylinder head screw DIN912 M 6 x 20	1 Stk	
		16	113434	Slide bushing JUM - 01 - 12	2 Stk	
		17	114494	Pin d 17 x 20	2 Stk	
		18	F29317	O-ring Ø 24 x 3	1 Stk	
		19	F24735	Threaded pin DIN551 M 6 x 12	2 Stk	

## 2 - Block - 114149











		<i>Position No.</i>	<i>Part No.</i>	<i>Designation</i>	<i>Quantity</i>	
		1	114138	Block 280 x 265 x 75	1 Stk	
		2	114146	Plate / sheet 224 x 60 x 4	1 Stk	
		3	F29306	Bolt Ø 19,5 x 25	17 Stk	
		4	F29102	Threaded insert M 6 x M 10 x 14	12 Stk	
		5	F20048	Countersunk bolt DIN7991 M 6 x 16	12 Stk	
		6	F20114	Pressure spring d1.8 x De19 x 285	17 Stk	
		7	F255839	Thread insert M 5 x M 8 x 10	4 Stk	
		8	114446	Handle 85 x 80 x 4	1 Stk	

## 23 - Distributor unit - 114150









		<i>Position No.</i>	<i>Part No.</i>	<i>Designation</i>	<i>Quantity</i>	
		1	114139	Distributor unit 270 x 68 x 48	1 Stk	
		2	109413	Guide d 60 x 7,5	1 Stk	
		3	114171	Bushing Distributor unit	17 Stk	
		4	113728	Plug M 24 x 1,5 x d 35 x 12	1 Stk	
		5	114147	Plate 242 x 45 x 3	1 Stk	
		6	113444	Bushing d 20 x d 4,2 x 8,5	17 Stk	
		9	110476	Bushing d 18 x 19,5	1 Stk	
		10	F255839	Thread insert M 5 x M 8 x 10	2 Stk	
		11	F29102	Threaded insert M 6 x M 10 x 14	4 Stk	
		12	109058	Countersunk bolt DIN7972 3,9 x 16	6 Stk	
		15	F248555	Countersunk bolt DIN7991 M 5 x 20	2 Stk	

		<i>Position No.</i>	<i>Part No.</i>	<i>Designation</i>	<i>Quantity</i>	
		16	110308	O-ring Silicon 70 red FDA	1 Stk	
		17	108962	Hollow ball d 10	1 Stk	

## 3 - Bushing - 114171







		<i>Position No.</i>	<i>Part No.</i>	<i>Designation</i>	<i>Quantity</i>	
		1	113442	Bushing d 17,9 x 31,5	1 Stk	
		3	113446	O-ring d 9 x 1,5	1 Stk	
		4	113445	O-ring d 10 x 1,5	1 Stk	
		5	113452	Rod seal d 8 x d 4 x 3	2 Stk	
		6	113443	Lid d 11,5 x d 4,2 x 4	1 Stk	

## 47 - Plate - 114492

		<i>Position No.</i>	<i>Part No.</i>	<i>Designation</i>	<i>Quantity</i>	
		1	114447	Housing 260 x 152,5 x 35 x 5	1 Stk	
		2	114437	Plate 260 x 142 x 15	1 Stk	
		3	114438	Plate 246 x 142 x 10	1 Stk	
		4	F20598	Countersunk bolt DIN7991 M 5 x 12	4 Stk	



## 50 - Shaft - 114448

		<i>Position No.</i>	<i>Part No.</i>	<i>Designation</i>	<i>Quantity</i>	
		1	114436	Shaft d 20 x 659	1 Stk	
		2	113846	Disc d 28 x 14 x 3	2 Stk	
		3	113731	Bushing d 20,2 x d 37,5 x 27	1 Stk	

## 4 - Drive - 8IR1705

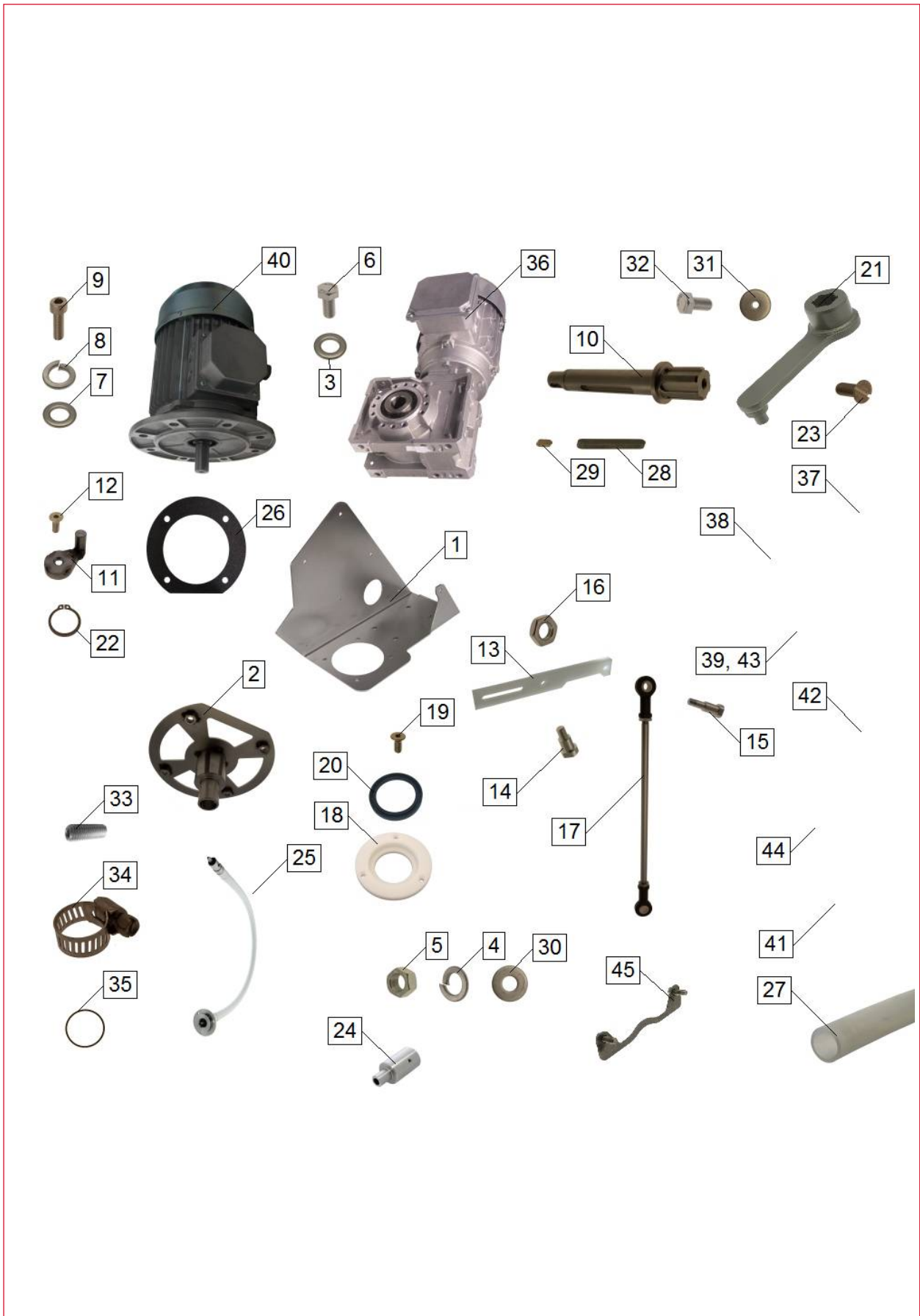

## 4 - Drive - 8IR1705







		<i>Position No.</i>	<i>Part No.</i>	<i>Designation</i>	<i>Quantity</i>	
		1	108932	Profile 446 x 358,6 x 217,9 x 4	1 Stk	
		2	109195	Flange IR 17	1 Stk	
		3	F22888	Washer DIN125 A 8,4	4 Stk	
		4	F21260	Spring lock washer DIN127 B 8	10 Stk	
		5	F20259	Hexagonal nut DIN934 M 8	10 Stk	
		6	F20455	Hexagonal bolt DIN933 M 8 x 25	4 Stk	
		7	F27693	Washer DIN125 A 10,5	6 Stk	
		8	F26379	Spring lock washer DIN127 B 10	4 Stk	
		9	F27479	Cylinder head screw DIN912 M10 x 35	4 Stk	
		10	106881	Shaft d 35 x 196	1 Stk	
		11	109619	Eccentric tappet IR 17	1 Stk	

		<i>Position No.</i>	<i>Part No.</i>	<i>Designation</i>	<i>Quantity</i>	
		12	F20048	Countersunk bolt DIN7991 M 6 x 16	1 Stk	
		13	109121	Lever 35 x 15 x 277	1 Stk	
		14	109163	Screw d 19,5 x 36,3	1 Stk	
		15	109164	Screw d 19,5 x 52	1 Stk	
		16	F20047	Hexagonal nut DIN439 M 10	2 Stk	
		17	106901	Connecting Rod IR 17	1 Stk	
		18	108987	Flange d 100 x 15	1 Stk	
		19	F20598	Countersunk bolt DIN7991 M 5 x 12	3 Stk	
		20	F28057	Radial shaft seal Ø 50 x Ø 65 x 8	1 Stk	
		21	113973	Lever IR 29	1 Stk	
		22	F25429	Locking ring DIN471 Ø 25 x 1,2	1 Stk	
		23	F21490	Countersunk bolt DIN963 M 8 x 20	1 Stk	

		<i>Position No.</i>	<i>Part No.</i>	<i>Designation</i>	<i>Quantity</i>	
	24	110605	Adapter Ø 30 x 65	1 Stk		
	25	110998	Drive shaft L=1102mm	1 Stk		
	26	109436	Absorber d 200 x 3	1 Stk		
	27	111512	Silicon hose Ø 25 x 3	1050 mm		
	28	F20561	Spring key A 8 x 7 x 70	1 Stk		
	29	F20222	Adjusting spring A 6 x 6 x 16	1 Stk		
	30	F26600	Disc Ø 8,5 x Ø 20 x 2	6 Stk		
	31	F22116	Disc Ø 6,5 x Ø 30 x 3	1 Stk		
	32	F20685	Hexagonal bolt DIN933 M 6 x 10	1 Stk		
	33	F25432	Threaded pin DIN914 M 6 x 10	1 Stk		
	34	F20165	Hose clamp HAS 16 Ø 17-38	1 Stk		
	35	F27892	O-ring Ø 44 x 2	2 Stk		

		<i>Position No.</i>	<i>Part No.</i>	<i>Designation</i>	<i>Quantity</i>	
	36	108971	Gear motor 2/4 CEGC 080Sa	1 Stk		
	37	F23730	Cable ÖZ-J 7 x 1.5 mm <sup>2</sup>	800 mm		
	38	F27324	Cable end sleeve 1,5 mm <sup>2</sup> black	7 Stk		
	39	F27686	Crimp type socket 620/4, red isolated	7 Stk		
	40	109403	Pump motor CIMRMT080E2s TD-B5	1 Stk		
	41	F147522	Sticker arrow	2 Stk		
	42	F27759	Cable ÖCYZ-J 4x1.5 mm <sup>2</sup>	1000 mm		
	43	F27686	Crimp type socket 620/4, red isolated	8 Stk		
	44	F21363	Crimp type socket 630/4, blue isolated	1 Stk		
	45	114744	Starting sheet IR 17	2 Stk		

## 17 - Connecting Rod - 106901

		<i>Position No.</i>	<i>Part No.</i>	<i>Designation</i>	<i>Quantity</i>	
		1	106900	Shaft Ø 14 x 386	1 Stk	
		2	106897	Joint Bearing KBRM-14	2 Stk	
		3	F26133	Hexagonal nut DIN439 M 14	2 Stk	

## 5 - Conveyor belt - 109225





























## 5 - Conveyor belt - 109225

		<i>Position No.</i>	<i>Part No.</i>	<i>Designation</i>	<i>Quantity</i>	
		1	110027	Conveyor belt IR 17	1 Stk	
		2	108960	Flange d 60 x 11,5	1 Stk	
		3	F23692	Radial shaft seal Ø 25 x Ø 35 x 6	1 Stk	
		4	108961	Flange d 60 x 13,7	1 Stk	
		5	108963	Lever 129 x 107 x 8	2 Stk	
		6	108964	Sprocket wheel d 60 x 8	2 Stk	
		7	108973	Bolt 21 x 9,9 x 8	2 Stk	
		8	F23269	Pressure spring d0.75 x De5.65 x 15	2 Stk	
		9	109103	Flange d 60 x 11,5	1 Stk	
		10	109245	Flange d 60 x 14,5	1 Stk	
		11	109075	Shaft d 14 x 325	1 Stk	





		<i>Position No.</i>	<i>Part No.</i>	<i>Designation</i>	<i>Quantity</i>	
		12	108958	Shaft d 38 x 289,5	1 Stk	
		13	F22943	Threaded pin DIN551 M 6 x 30	1 Stk	
		14	109074	Disc d 22,1 x d 85 x 2,5	2 Stk	
		15	F25887	O-ring Ø 14 x 2	1 Stk	
		16	109560	Countersunk head wood screw d 5 x 16	8 Stk	
		17	109162	Bolt d 14 x 34,5	1 Stk	
		18	F20262	Locking ring DIN471 Ø 14 x 1	1 Stk	
		19	109996	Filter IR 17	1 Stk	
		20	110937	Bushing Ø 30 x 17	1 Stk	
		21	F22116	Disc Ø 6,5 x Ø 30 x 3	1 Stk	
		22	F250798	Hexagonal nut DIN985 M 6	1 Stk	

## 1 - Conveyor belt - 110027

		<i>Position No.</i>	<i>Part No.</i>	<i>Designation</i>	<i>Quantity</i>	
		1	110024	Conveyor belt IR 17	1 Stk	
		2	110020	Discharge IR 17	1 Stk	
		3	108946	Shaft d 14 x 252	1 Stk	
		4	108933	Shaft d 30 x 252	1 Stk	
		5	110025	Shaft Ø 14 x 258	1 Stk	
		6	110026	Shaft Ø 30 x 258	1 Stk	
		7	F21047	Hexagonal bolt DIN933 M 6 x 12	8 Stk	
		8	108940	Shaft d 20 x 252	2 Stk	
		9	F29102	Threaded insert M 6 x M 10 x 14	4 Stk	
		10	108954	Plate 186 x 25 x 10	2 Stk	
		11	109932	Support 479 x 25 x 10	5 Stk	

		<i>Position No.</i>	<i>Part No.</i>	<i>Designation</i>	<i>Quantity</i>	
		12	108947	Foot d 18 x 18,7	2 Stk	
		13	109073	Foot d 18 x 25	2 Stk	
		14	109588	Cylindrical pin Ø 5 x 18,5	4 Stk	
		15	110021	Bolt d 12 x 14,5	2 Stk	
		16	108166	Shaft Ø 15 x 251,5	1 Stk	
		17	114157	Wire mesh belt 250 mm	2000 mm	
		18	109561	Bushing d 2,5 x 30	3 Stk	
		19	110111	Support plate 65 x 20 x 10	2 Stk	
		20	109407	Countersunk head screw DIN 7972 3,9 x 9,5	9 Stk	
		21	114158	Sleeve d 3 x 40	3 Stk	

## 19 - Filter - 109996

		<i>Position No.</i>	<i>Part No.</i>	<i>Designation</i>	<i>Quantity</i>	
		1	108972	Filter 710,3 x 263 x 1,5	1 Stk	
		2	109246	Guide 390,7 x 42,4 x 5	1 STK	

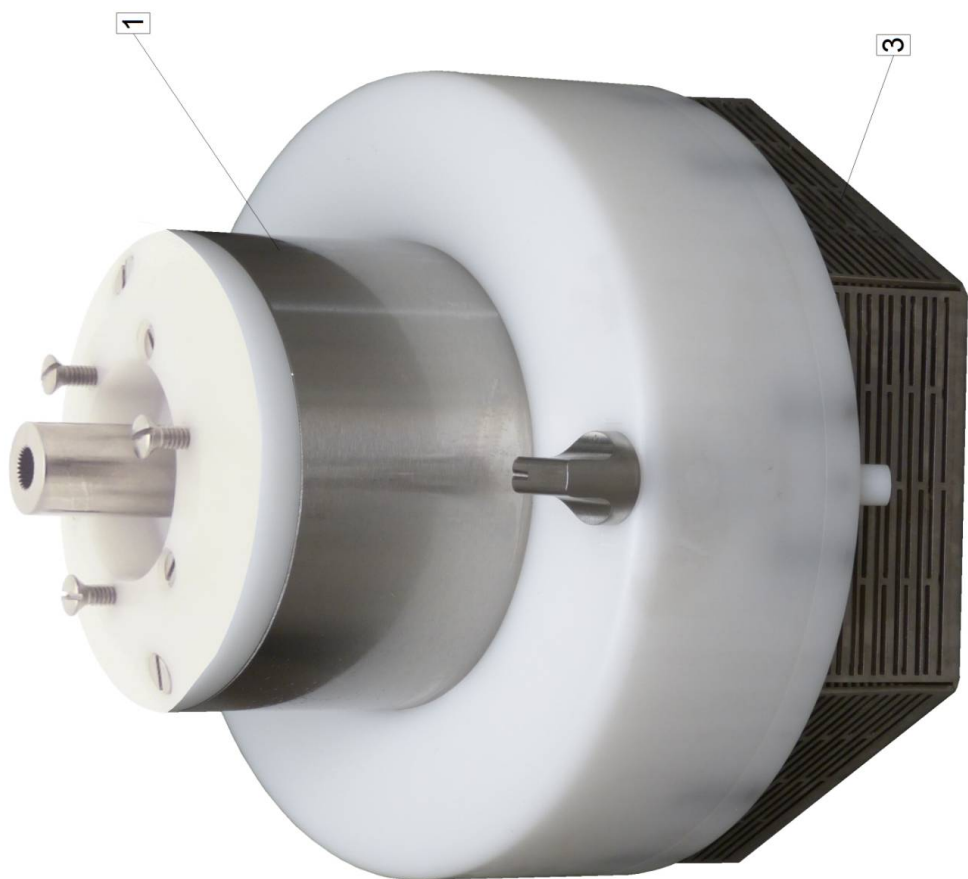

## 6 - Pump - 114105



## 6 - Pump - 114105

		<i>Position No.</i>	<i>Part No.</i>	<i>Designation</i>	<i>Quantity</i>	
		1	113990	Pump K-9236-2XP	1 Stk	
		2	107046	Bolt d 15 x 48	3 Stk	
		3	114092	Filter plate 178 x 155 x 41,5 x 1,5	1 Stk	
		4	F26993	Hexagonal bolt DIN933 M 5 x 10	3 Stk	
		5	112331	Threaded sleeve Ø 28 x 46	1 Stk	
		6	107524	Raised countersunk-head screw DIN964 M 5 x 30	3 Stk	

## 1 - Pump - 113990

		<i>Position No.</i>	<i>Part No.</i>	<i>Designation</i>	<i>Quantity</i>	
		1	110785	Adapter M 16 x Ø 20 x 40	1 Stk	





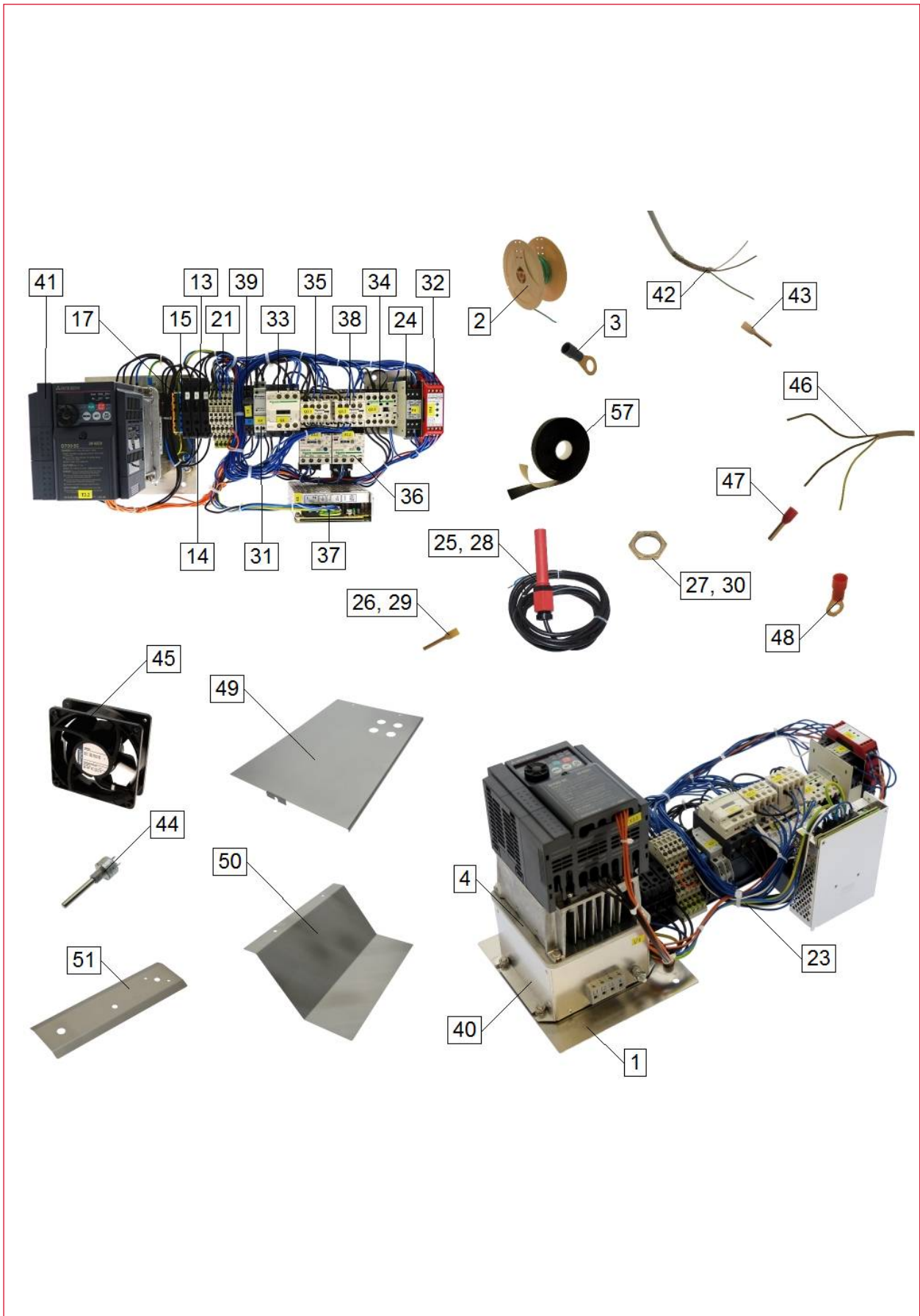





















## 7 - Switch box - 109720et



## 7 - Switch box - 109720et

		<i>Position No.</i>	<i>Part No.</i>	<i>Designation</i>	<i>Quantity</i>	
	2	F27323	Litz 2.5mm <sup>2</sup> H07V-K 2,5 mm <sup>2</sup> gn/ge	150 mm		
	3	F27683	Crimp type socket 630/6, blue isolated	2 Stk		
	4	110986	Flanged plate 130 x 120 x 6	1 Stk		
	5	F23492	Countersunk screw DIN85 M 3 x 10	2 Stk		
	6	F20258	Washer DIN125 A 6,4	5 Stk		
	7	F26145	Hexagonal nut DIN934 M 6	4 Stk		
	8	F21688	Countersunk bolt DIN7991 M 5 x 10	4 Stk		
	9	F28952	Cylinder head screw DIN84 M 4 x 12	4 Stk		
	10	F28732	Lock washer DIN6797-A ø 6,4	1 Stk		
	11	F24031	Spring lock washer DIN127 B 6	1 Stk		
	12	F20203	Hexagonal nut DIN934 M 6	1 Stk		

		<i>Position No.</i>	<i>Part No.</i>	<i>Designation</i>	<i>Quantity</i>	
		13	F27066	Fuse terminal block 6.4 x 32 mm	3 Stk	
		14	105013	Fuse 10 AT 6,3 x 32 mm	3 Stk	
		15	F27054	Terminal - 2x, blue 4mm <sup>2</sup>	1 Stk	
		16	F20721	Side plate blue FEM 4A	1 Stk	
		17	F20719	Protective conductor terminal 2x 4mm <sup>2</sup>	1 Stk	
		18	F28277	Side plate green FEM 4AP V0	1 Stk	
		19	F28278	End terminal BNK - BADL	1 Stk	
		20	F27067	Side plate black FEM 13U	1 Stk	
		21	107605	Terminal - 3x, with PU WKF 4 3D/SL35	5 Stk	
		22	109681	Offset nipple M25	5 Stk	
		24	F28956	Monitoring unit MÜZ 202/D24-FL	1 Stk	
		25	F20741	Solenoid switch MAK 2626-2	1 Stk	

		<i>Position No.</i>	<i>Part No.</i>	<i>Designation</i>	<i>Quantity</i>	
	26	F27789	Cable end sleeve 0,25 mm² yellow	4 Stk		
	27	F20300	Hexagonal nut PG 9	1 Stk		
	28	F20741	Solenoid switch MAK 2626-2	1 Stk		
	29	F27789	Cable end sleeve 0,25 mm² yellow	4 Stk		
	30	F20300	Hexagonal nut PG 9	1 Stk		
	31	112007	Phase sequence relay 70.61.8.400.0000	1 Stk		
	32	106695	Emergency stop safety relay SCR 4-W22-3.5-D	1 Stk		
	33	F28667	Power contactor 24VDC LC1 D18BD	1 Stk		
	34	F27091	Power contactor 24VDC LP1 K0910 BD3	1 Stk		
	35	F20916	Turn contactor LP2-K0910 BD3	1 Stk		
	36	F22283	Motor protect. relay 1.8 -2.6A LR 2-K0308	2 Stk		
	37	111353	Power supply 230VAC/24VDC RS-75-24	1 Stk		

		<i>Position No.</i>	<i>Part No.</i>	<i>Designation</i>	<i>Quantity</i>	
	38	106925	Aux. switch block LA1 KN22	2 Stk		
	39	F41539	Relay 2 We / 24 VDC / 6A	1 Stk		
	40	110963	Line filter 8A EPA NF-S-414605/1-8	1 Stk		
	41	110587	Programmed FC FR-D740-050 SC-EC	1 Stk		
	42	F20700	Cable Liqcy 3 x 0.5 mm <sup>2</sup>	400 mm		
	43	F27358	Cable end sleeve 0,5 mm <sup>2</sup> white	3 Stk		
	44	F254436	Potentiometer PE 30 AL - LIN A 10 kOhm	1 Stk		
	45	109488	Ventilator RAH1238S1	1 Stk		
	46	F23343	Cable ÖZ-J 3 x 1.0 mm <sup>2</sup>	1000 mm		
	47	F27357	Cable end sleeve 1,0 mm <sup>2</sup> red	2 Stk		
	48	F27686	Crimp type socket 620/4, red isolated	1 Stk		
	49	110285	Plate / sheet 424 x 294 x 13,5 x 0,5	1 Stk		

		<i>Position No.</i>	<i>Part No.</i>	<i>Designation</i>	<i>Quantity</i>	
	50	110284	Plate / sheet 294 x 191 x 97 x 0,5	1 Stk		
	51	110283	Plate / sheet 203 x 60,4 x 5 x 0,5	1 Stk		
	52	F20258	Washer DIN125 A 6,4	6 Stk		
	53	F250798	Hexagonal nut DIN985 M 6	5 Stk		
	54	F26993	Hexagonal bolt DIN933 M 5 x 10	2 Stk		
	55	F21028	Hexagonal nut DIN934 M 5	2 Stk		
	56	F27693	Washer DIN125 A 10,5	4 Stk		
	57	F144446	Seal 50 mm Armaflex	500 mm		
	58	F28732	Lock washer DIN6797-A ø 6,4	1 Stk		
	59	F24031	Spring lock washer DIN127 B 6	1 Stk		
	60	F20203	Hexagonal nut DIN934 M 6	1 Stk		

## 8 - Hose laying - 109468

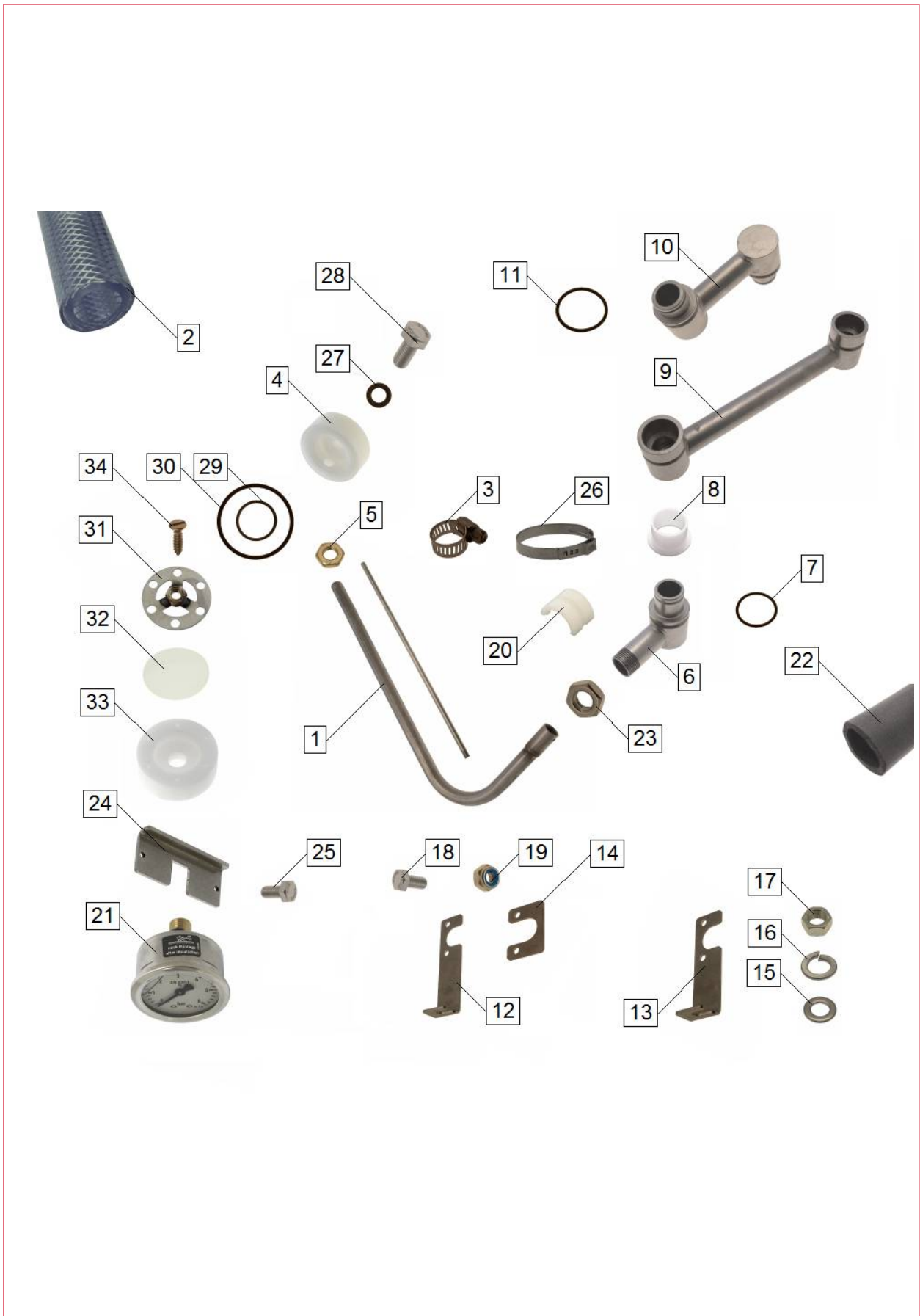

## 8 - Hose laying - 109468

		<i>Position No.</i>	<i>Part No.</i>	<i>Designation</i>	<i>Quantity</i>	
		1	109548	Tube IR 17	1 Stk	
		2	F27648	Hose Ø 19 x 5	1070 mm	
		3	F20165	Hose clamp HAS 16 Ø 17-38	2 Stk	
		4	110371	Housing Ø 52,5 x 22	1 Stk	
		5	F21508	Hexagonal nut DIN439 M 10 x 1	1 Stk	
		6	109545	Swivel IR 17	1 Stk	
		7	109046	O-ring Ø 21,95 x 1,78	2 Stk	
		8	109538	Slide bushing iglidur A180	2 Stk	
		9	109546	Swivel IR 17	1 Stk	
		10	109547	Swivel IR 17	1 Stk	
		11	109045	O-ring Ø 23,52 x 1,78	1 Stk	



		<i>Position No.</i>	<i>Part No.</i>	<i>Designation</i>	<i>Quantity</i>	
		12	109474	Bracket 112 x 28 x 25 x 2,5	1 Stk	
		13	109476	Bracket 97 x 28 x 25 x 2,5	1 Stk	
		14	109478	Plate / sheet 48 x 35 x 2,5	2 Stk	
		15	F22888	Washer DIN125 A 8,4	2 Stk	
		16	F21260	Spring lock washer DIN127 B 8	2 Stk	
		17	F20259	Hexagonal nut DIN934 M 8	2 Stk	
		18	F21047	Hexagonal bolt DIN933 M 6 x 12	4 Stk	
		19	F250798	Hexagonal nut DIN985 M 6	4 Stk	
		20	109386	Guide d 45 x 33	4 Stk	
		21	114491	Pressure gauge 0 to 6 bar	1 Stk	
		22	109624	Armaflex hose HT/B2-10x054	100 mm	
		23	F240479	Hexagonal nut DIN439 M 22 x 1,5	1 Stk	

		<i>Position No.</i>	<i>Part No.</i>	<i>Designation</i>	<i>Quantity</i>	
		24	110392	Plate / sheet 68 x 27 x 10 x 2	1 Stk	
		25	103733	Hexagonal bolt DIN933 M 4 x 50	2 Stk	
		26	110219	Clamp d 46 x 7	2 Stk	
		27	F27928	O-ring Ø 6 x 2	1 Stk	
		28	F20455	Hexagonal bolt DIN933 M 8 x 25	1 Stk	
		29	F27890	O-ring Ø 30 x 2,5	1 Stk	
		30	F24237	O-ring Ø 45 x 2,5	1 Stk	
		31	111040	Disc IR 17	1 Stk	
		32	110624	Silicon disc Ø 50 x 1	1 Stk	
		33	110390	Housing Ø 50 x 18	1 Stk	
		34	109058	Countersunk bolt DIN7972 3,9 x 16	6 Stk	



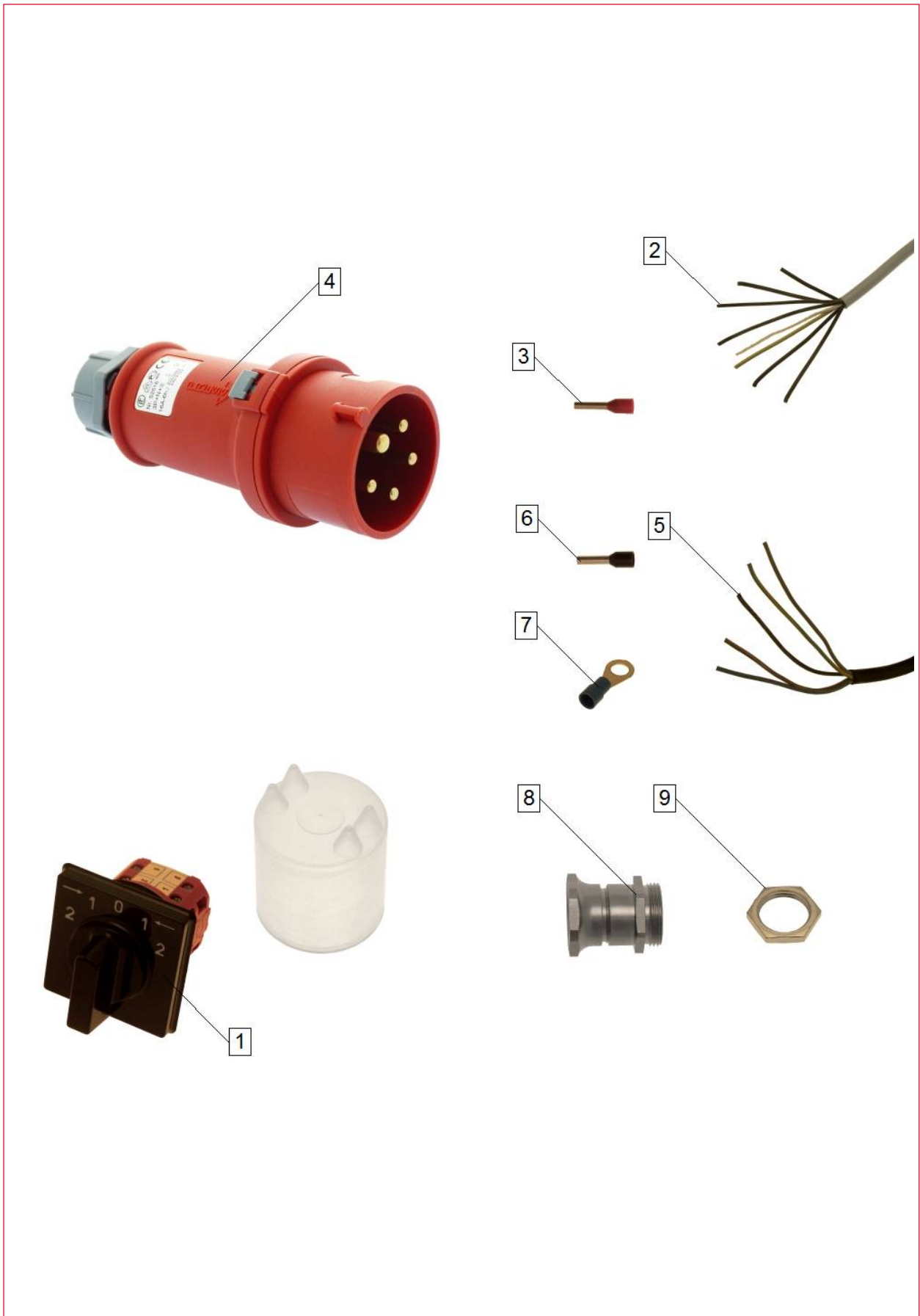

## 9 - Power supply - 8IR1701



## 9 - Power supply - 8IR1701

		<i>Position No.</i>	<i>Part No.</i>	<i>Designation</i>	<i>Quantity</i>	
	1	109284	Cam switch V2N HF25H-BH-SS	1 Stk		
	2	F25303	Cable ÖZ-J 7x1.0 mm <sup>2</sup>	500 mm		
	3	F27357	Cable end sleeve 1,0 mm <sup>2</sup> red	14 Stk		
	4	F26441	CEE socket 16A-6h 5-pin 400V	1 Stk		
	5	F22457	Cable H07RN-F 5G1.5	6500 mm		
	6	F27324	Cable end sleeve 1,5 mm <sup>2</sup> black	4 Stk		
	7	F27683	Crimp type socket 630/6, blue isolated	1 Stk		
	8	F242947	Cable gland M 25 x 1.5 / brass	1 Stk		
	9	F29060	Hexagonal nut M 25 x 1,5	1 Stk		

## 10 - Equipment - 8IR1702

		<i>Position No.</i>	<i>Part No.</i>	<i>Designation</i>	<i>Quantity</i>	
		1	114267	Plate 259 x 330 x 15	1 Stk	
		2	110216	Hand sprayer IR 17	1 Stk	

# RÜHLE



Jorge Estrela | Director of Sales

CM Machine Services Ltd.

I-55 Stafford Dr.

Brampton, On L6W-1L3 Canada

905-793-3994 Ext 221 Fax: 905-230-3995 [www.cmmachineservices.net](http://www.cmmachineservices.net)